

03PBTT



Qualificada pela E-REDES
DMA-C62-807/N
Edição 3



PORTINHOLA PBT EQUIPADA

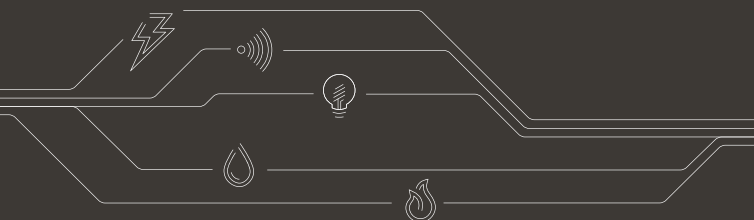

03PBTM

03PBTT

PORTINHOLA EQUIPADA MONOFÁSICA
COM ISF00 E BASE NEUTRO SECCIONÁVEL

PORTINHOLA EQUIPADA TRIFÁSICA
COM ISF00 E BASE NEUTRO SECCIONÁVEL

Montagem Interior, Exterior e Encastrada

03PBTM: 1 un x ISF1-00 T00
03PBTT: 3 un x ISF1-00 T00

Efetuar furação conforme o
desenho abaixo

Base Neutro T00 Seccionável

Fabricada de acordo
com as normas:
DMA-C62-807/N
e EN61439

Corrente nominal:
160A

Tensão nominal:
03PBTM - 230V
03PBTT - 400V

IP45 IK10

Classe II
Isolamento

Preparada p/ fechadura
tipo "Rónis" (20176459)
e fechadura triangular
ref.º AL 16FH9

Ref.º do Invólucro vazio: 06PBT

Material caixa e porta: Poliéster reforçado a
fibra de vidro auto-extinguível cinza RAL 7035

Material placa de montagem: ABS (ajustável em altura)

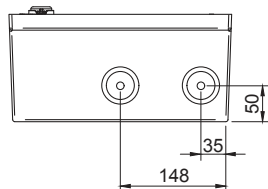

vista inferior

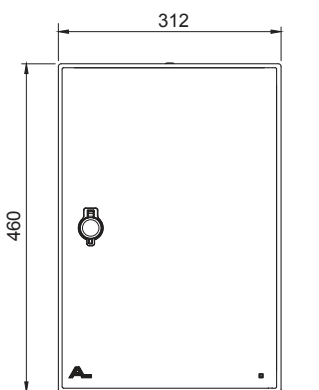

vista frontal



vista lateral
esquerda

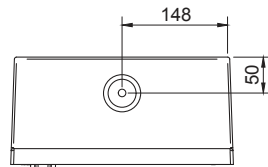

vista superior

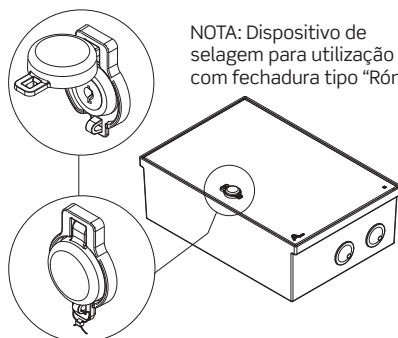

NOTA: Dispositivo de
selagem para utilização
com fechadura tipo "Rónis"

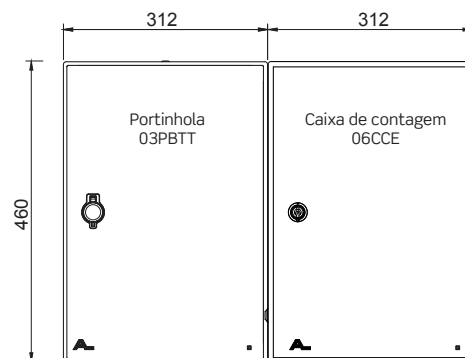

Portinhola com a mesma altura e largura
da Caixa de Contagem

FP-006G/1

PRÓDUTO FABRICADO
E MONTADO EM PORTUGAL

Consulte a nossa gama completa
de produtos em www.al.pt



AL - Fábrica de Material Eléctrico, SA
Zona Industrial Casal da Lebre
Rua da Alemanha, Lote 6B
2430-028 Marinha Grande
Portugal

+351 244 572 280
(chamada para rede fixa nacional)

geral@al.pt
comercial@al.pt

www.al.pt



03PBTE400T



Qualificada pela E-REDES
DMA-C62-807/N
Edição 3



PORTINHOLA PBTE 400

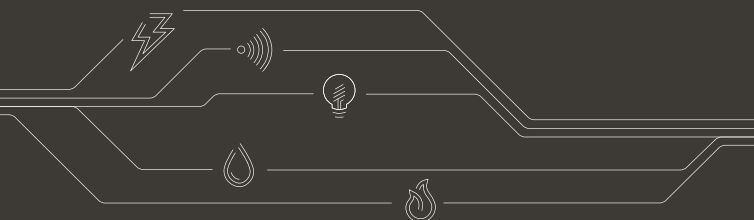

03PBTE400T PORTINHOLA EQUIPADA TRIFÁSICA COM ISF2 E BASE NEUTRO SECCIONÁVEL

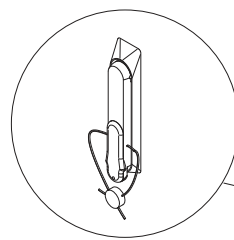
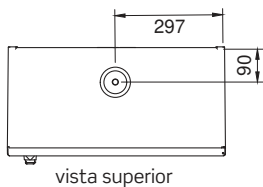
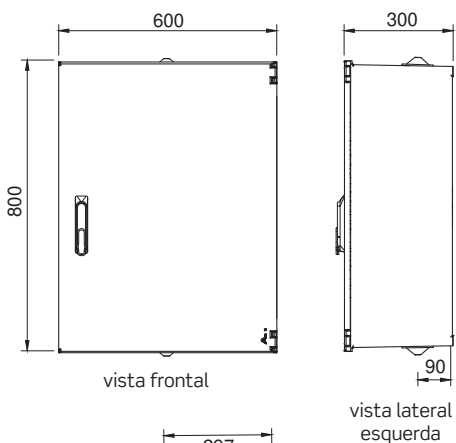
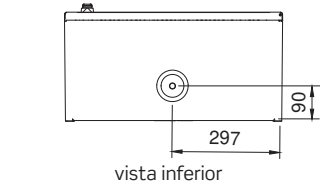
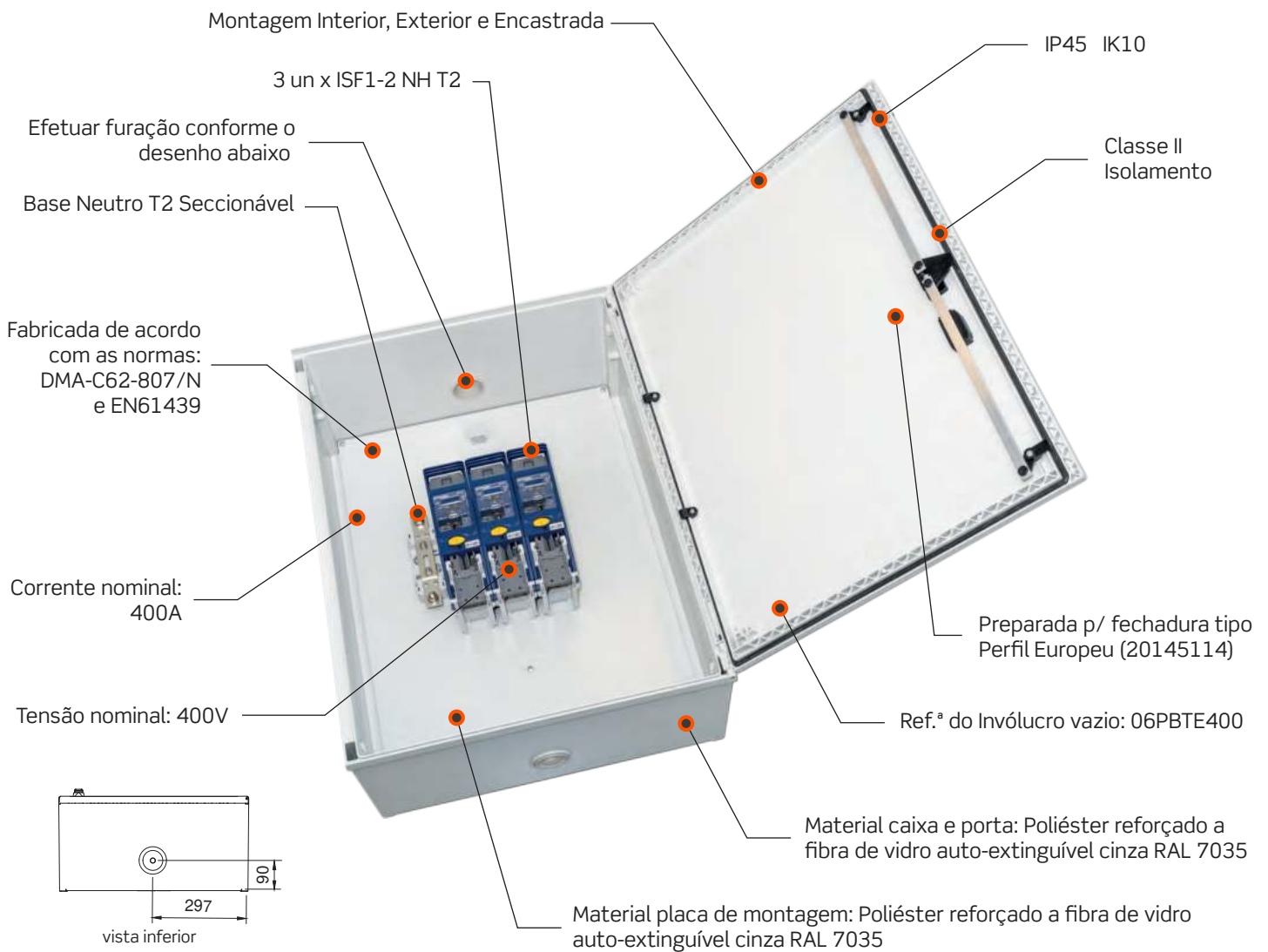

NOTA: Manípulo preparado para fio de selagem

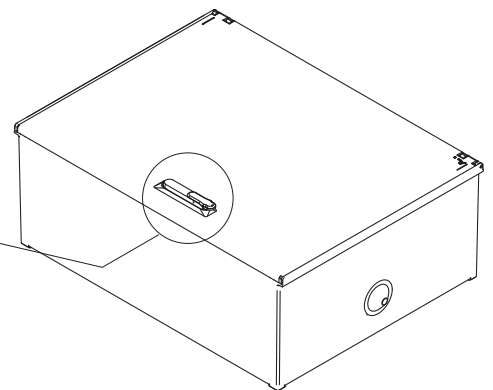

PRODUTO FABRICADO E MONTADO EM PORTUGAL



Consulte a nossa gama completa de produtos em www.al.pt



AL - Fábrica de Material Eléctrico, SA
Zona Industrial Casal da Lebre
Rua da Alemanha, Lote 6B
2430-028 Marinha Grande
Portugal

+351 244 572 280
(chamada para rede fixa nacional)

geral@al.pt
comercial@al.pt

www.al.pt





Qualificada
pela EDP
DMA-C62-805/N

06CCE



Caixa de contagem de energia

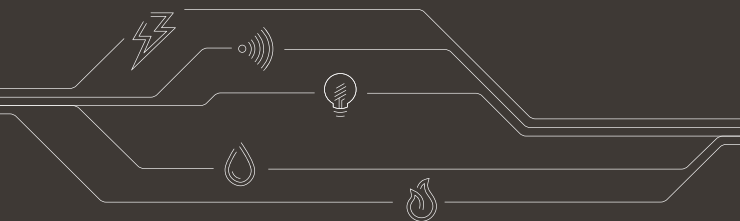

Caixa de Contagem de Energia

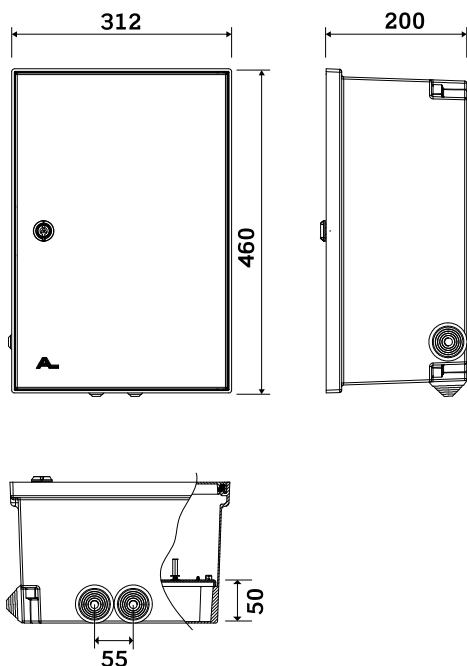
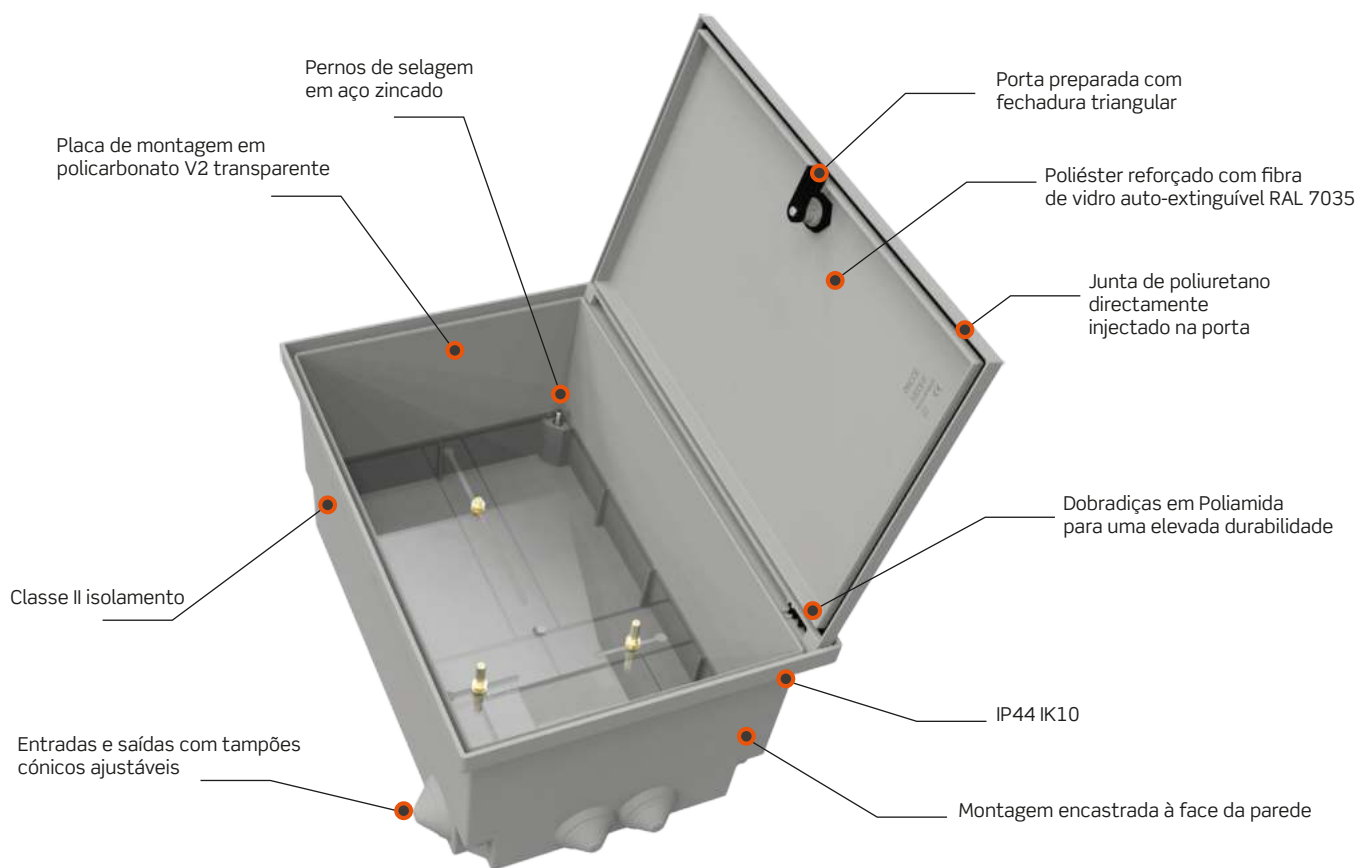

Todas as medidas em mm.



Qualificada
pela EDP
DMA-C62-805/N

06CCE

Montagem

Caixa de contagem para instalação de contador monofásico/trifásico em clientes residenciais

Norma aplicável: EN 62208

- Tensão de isolamento 600V
- Gama de temperatura suportada pelo invólucro: - 25°C a +60°C
- Capacidade de dissipação térmica: 14W
- Livre de halogéneos

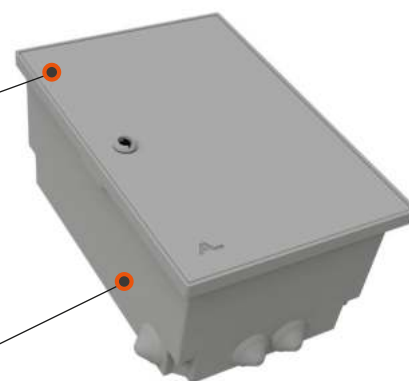

PRODUTO FABRICADO
E MONTADO EM PORTUGAL



Consulte a nossa gama completa de produtos em www.al-sa.pt



AL - Fábrica de Material Eléctrico, SA
Zona Industrial Casal da Lebre
Rua da Alemanha, Lote 6B
2430-028 Marinha Grande
Portugal

+351 244 572 280
+351 244 572 290

geral@al-sa.pt
comercial@al-sa.pt

www.al-sa.pt

